



WELLBORN
CABINET®

2024 PRODUCT
LAUNCH SUMMARY

2024 NEW PRODUCT SUMMARY

TABLE OF CONTENTS

DOOR STYLES	SERIES	CABINETS	SERIES
Beaumont	PRE, ASR	18" High, Box Hoods - New Size (except X-Panel Box Hood)	SEL, PRE, ASR
Breckenridge	PRE, ASR	6" Base Tray Cabinet	SEL, PRE, ASR
Collins	PRE, ASR	2DB33HD - New Size	PRE, ASR
Everett	PRE	3DB42 - New Size	PRE
Langley	PRE	4DB39 & 4DB42 - New Sizes	PRE
Marlow	PRE, ASR	Wastebasket Cutting Board Cabinets	SEL, PRE, ASR
Ridgebrook	PRE, ASR	Cleaning Utility Cabinet (CUC)	SEL, PRE
Wyatt	PRE, ASR	Spice Utility Cabinet (SUC)	SEL, PRE
Galena Square Inset	PRE	Vanity Power Pullout	PRE
Prairie Inset	PRE	Pocket Door Stack Cabinets w/Void Bottom Rail (PDSC_VBR)	PRE
Seville Square Inset	PRE		
Bedford Square in Hickory	SEL, ASR	ACCESSORIES	SERIES
Hanover in Hickory	PRE, ASR	2 & 4 Sliding Shelf Kits	SEL, PRE, ASR
Henlow Square in Hickory	PRE, ASR	Sliding Shelf Supports in 3 heights	SEL, PRE, ASR
FINISHES	SERIES	PRICING CHANGES	SERIES
Alabaster	SEL, PRE, ASR	Reduced number of Price Columns Price Column changes do not result in price change	SEL
Boardwalk	SEL, PRE, ASR	Reduced number of Price Columns Price Column changes do result in price changes Essex & Bishop changed columns (price increase) Hanover & Savannah changed columns (price decrease)	PRE
Peppermill	SEL, PRE, ASR		
MODIFICATIONS	SERIES		
Functional End Option to PRE Inset	PRE		
Integrated Matching End Option to PRE Inset	PRE		
Pocket Doors Installed (PDIN) expanded to more cabinets	PRE		
Pocket Doors Installed (PDIN) available w/Standard Maple Cabinet Interior	PRE		ASR
Drawer Installed Option Expanded to Include Triple Oven Cabinets (TO)	SEL, PRE		
Oven Tray Dividers & Shelf Combo Installed (OTDSIN)	SEL, PRE		
Classic Drawer Front Option to Franklin in SEL	SEL		
Wide Bottom Rail Option to CUC and SUC cabinets in SEL	SEL		

NEW DOOR STYLES

LAUNCHED 3/11/24

BEAUMONT

AVAILABLE IN PREMIER AND ASPIRE
REDESIGNED MADISON SQUARE

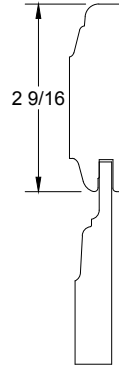

Detail

WOOD SPECIES:
Cherry, Maple, Oak,
Character Cherry, Character Maple

PREMIER PRICE COLUMN: 10

ASPIRE PRICE COLUMN: 8

ORDERING CODE: BEU

NOTES:

- Full Overlay
- Cope & Tenon Door Construction
- Detailed Door & Drawer Front Edges & Center Panel
- Solid Wood Raised Center Panel
- Standard One Piece Drawer Front
- Classic Drawer Front Option Available
- Hardware Opening Top Drawer: 1"

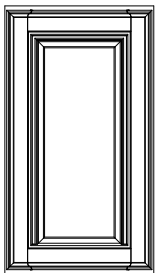

Wall

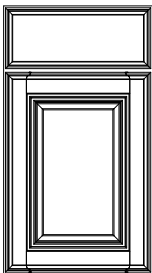

Base

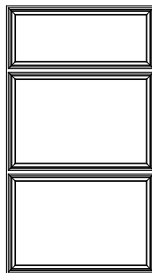

Standard

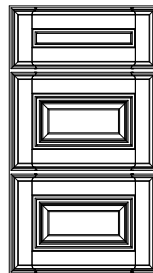

Classic

DOORS PREPPED FOR GLASS

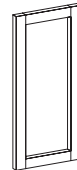

Decorative Door Frame

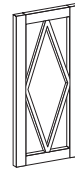

Chalet Mullion

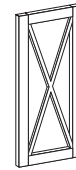

Cottage Mullion

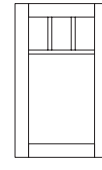

Craftsman Mullion



Traditional Mullion

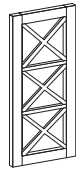

Villa Mullion

BRECKENRIDGE

AVAILABLE IN PREMIER AND ASPIRE

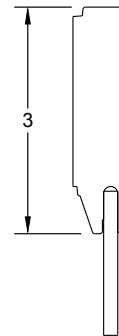

Detail

WOOD SPECIES:
Cherry, Maple ❖, Oak, MDF

PREMIER PRICE COLUMN: 9

ASPIRE PRICE COLUMN: 8

ORDERING CODE: BKR

NOTES:

- Full Overlay
- A simple step outside profile with a corresponding decorative inside profile
- Recessed Veneer Center Panel
- Slab Drawer Front
- Classic Drawer Front Option Available
- Hardware Opening Top Drawer: 2 1/8"

❖ Order MDF species for paints and paints with glazes. Maple available in stains and stains with glazes only.

DOORS PREPPED FOR GLASS

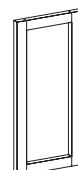

Decorative Door Frame

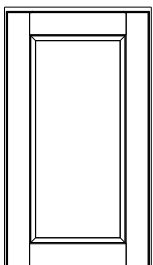

4 Wall

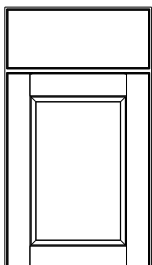

Base



Standard

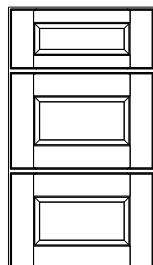

Classic

COLLINS

AVAILABLE IN PREMIER AND ASPIRE
REDESIGNED BRISTOL

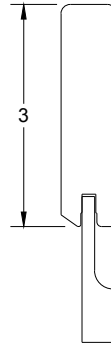

Detail

WOOD SPECIES:
Cherry, Maple, Oak,
Character Cherry, Character Maple

PREMIER PRICE COLUMN: 10

ASPIRE PRICE COLUMN: 8

ORDERING CODE: CLN

NOTES:

- Full Overlay
- Eased Edge Door and Drawer Front
- Beveled Inside Profile
- Solid Wood Reversed Flat Center Panel
- When painted maple is ordered the center panel will change to MDF
- 3" Stiles and Rails
- Slab Drawer Front
- Classic Drawer Front Option Available
- Hardware Opening Top Drawer: 2¹/₈"

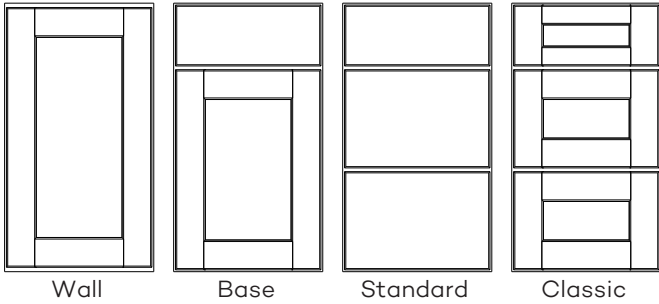

DOORS PREPPED FOR GLASS

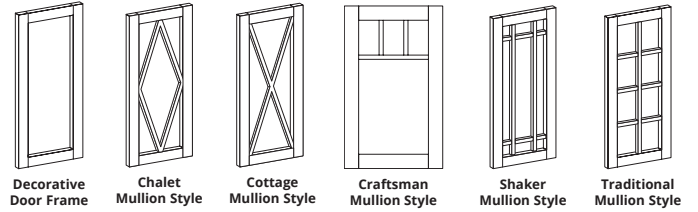

EVERETT

AVAILABLE IN PREMIER

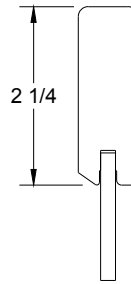

Detail

WOOD SPECIES:
Cherry, Maple ❖, Oak, MDF

PREMIER PRICE COLUMN: 6

ORDERING CODE: EVT

NOTES:

- Traditional Overlay
- Eased Edge Door and Drawer Front
- Beveled Inside Profile
- Veneer Recessed Center Panel
- Classic Drawer Front Option Available
- 5-piece Drawer Fronts will have solid Center Panels
- Hardware Opening Top Drawer: 1⁵/₈"

❖ Order MDF species for paints and paints with glazes. Maple available in stains and stains with glazes only.

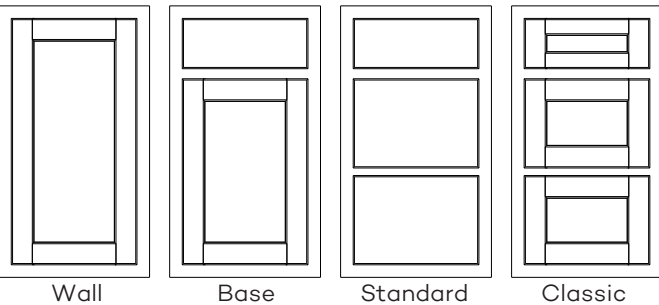

DOORS PREPPED FOR GLASS

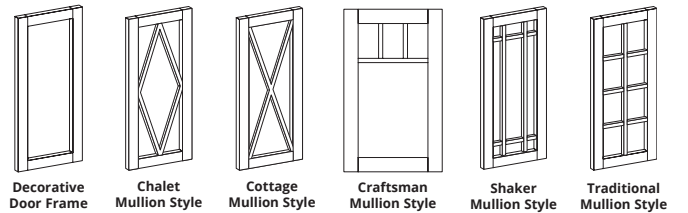

LANGLEY

AVAILABLE IN PREMIER

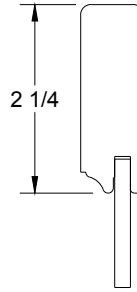

Detail

WOOD SPECIES:
Cherry, Maple ❖, Oak, MDF

PREMIER PRICE COLUMN: 6

ORDERING CODE: LGY

NOTES:

- Traditional Overlay
- Eased Edge Door and Drawer Front
- Ogee Inside Edge Profile
- Recessed Veneer Center Panel
- Slab Drawer Front
- Classic Drawer Front Option Available
- Hardware Opening Top Drawer: 1⁵/₈"

❖ Order MDF species for paints and paints with glazes. Maple available in stains and stains with glazes only.

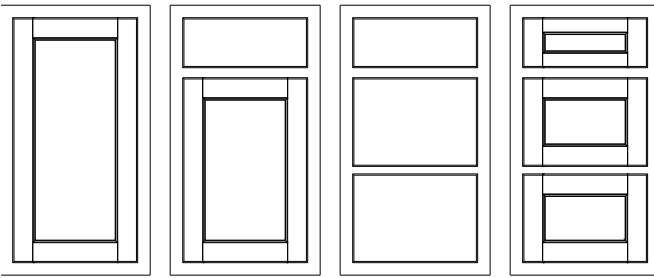

Wall

Base

Standard

Classic

DOORS PREPPED FOR GLASS

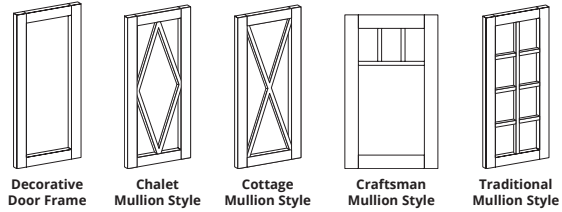

Decorative Door Frame

Chalet Mullion Style

Cottage Mullion Style

Craftsman Mullion Style

Traditional Mullion Style

MARLOW

AVAILABLE IN PREMIER AND ASPIRE
REDESIGNED MESSINA

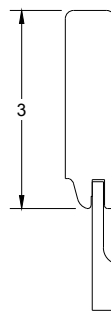

Detail

WOOD SPECIES:
Cherry, Maple, Oak,
Character Cherry, Character Maple

PREMIER PRICE COLUMN: 10

ASPIRE PRICE COLUMN: 8

ORDERING CODE: MRW

NOTES:

- Full Overlay
- Solid Wood Reversed Center Panel
- When painted maple is ordered the center panel will change to MDF
- 3" Stiles and Rails
- Slab Drawer Front
- Classic Drawer Front Option Available
- Hardware opening top drawer: 2¹/₈"

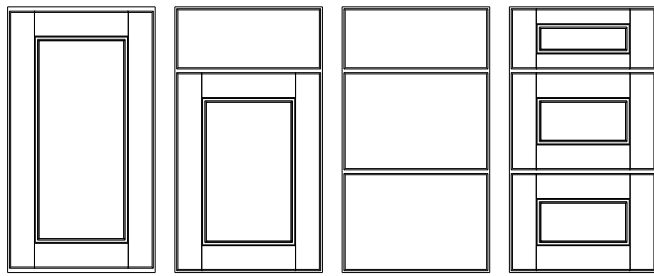

Wall

Base

Standard

Classic

DOORS PREPPED FOR GLASS

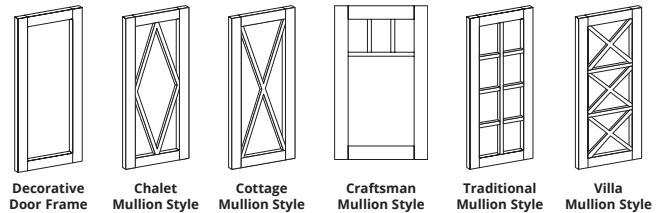

Decorative Door Frame

Chalet Mullion Style

Cottage Mullion Style

Craftsman Mullion Style

Traditional Mullion Style

Villa Mullion Style

RIDGEBROOK

AVAILABLE IN PREMIER AND ASPIRE

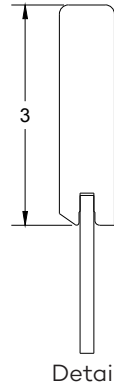

WOOD SPECIES:
Cherry, Maple❖, Oak, MDF

PREMIER PRICE COLUMN: 9

ASPIRE PRICE COLUMN: 8

ORDERING CODE: RBK

NOTES:

- Full Overlay
- Eased Door and Drawer Front Outside Edges
- Beveled inside profile
- 3" Stiles and Rails
- Veneer Recessed Center Panel
- Classic Drawer Front Option Available
- 5-piece Drawer Fronts will have solid Center Panels
- Hardware opening top drawer: 2¹/₈"

❖ Order MDF species for paints and paints with glazes. Maple available in stains and stains with glazes only.

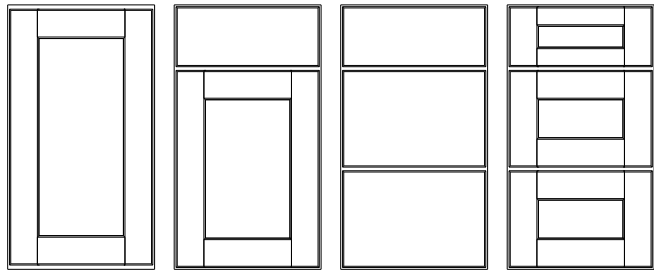

Wall

Base

Standard

Classic

DOORS PREPPED FOR GLASS

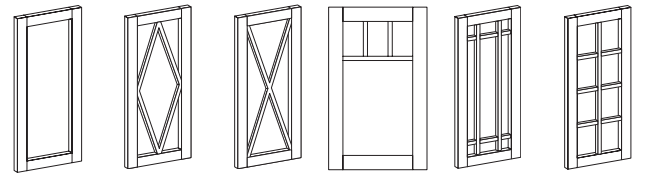

Decorative Door Frame

Chalet Mullion Style

Cottage Mullion Style

Craftsman Mullion Style

Shaker Mullion Style

Traditional Mullion Style

WYATT

AVAILABLE IN PREMIER AND ASPIRE
REDESIGNED WINSLOW

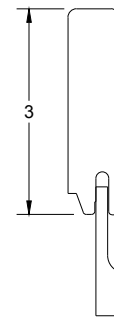

WOOD SPECIES:
Cherry, Maple❖, Oak, MDF,
Character Cherry, Character Maple

PREMIER PRICE COLUMN: 10

ASPIRE PRICE COLUMN: 8

ORDERING CODE: WYT

NOTES:

- Full Overlay
- Solid Wood Reversed Flat Center Panel
- 3" Stiles and Rails with Single Step Profiled Inside Edge
- Slab Drawer Front
- Classic Drawer Front Option Available
- Hardware Opening Top Drawer: 2¹/₈"

❖ Order MDF species for paints and paints with glazes. Maple available in stains and stains with glazes only.

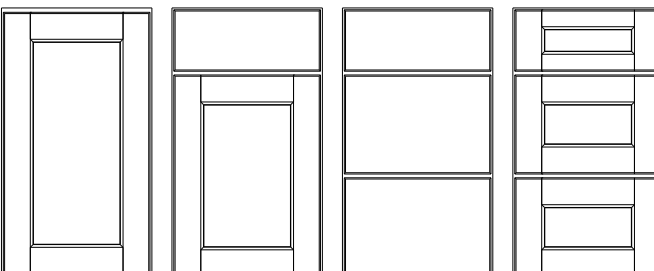

Wall

Base

Standard

Classic

DOORS PREPPED FOR GLASS

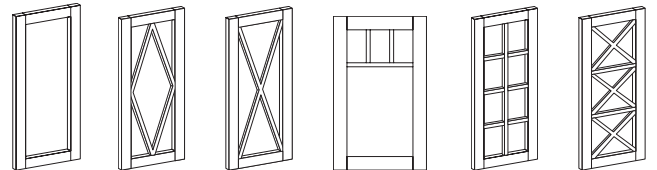

Decorative Door Frame

Chalet Mullion Style

Cottage Mullion Style

Craftsman Mullion Style

Traditional Mullion Style

Villa Mullion Style

GALENA SQUARE INSET AVAILABLE IN PREMIER

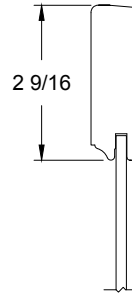

WOOD SPECIES:
Cherry, Maple, Oak, Hickory

PRICING: +15% to overlay door style

ORDERING CODE: GNS

NOTES:

- 1/16" Eased Edge Door and Drawer Front Edges with a Slight Back Bevel
- Recessed Veneer Center Panel
- When painted maple is ordered the center panel will change to MDF
- Classic Drawer Front Option Available for Top Drawer
- Tolerance Around Doors and Drawers will Vary

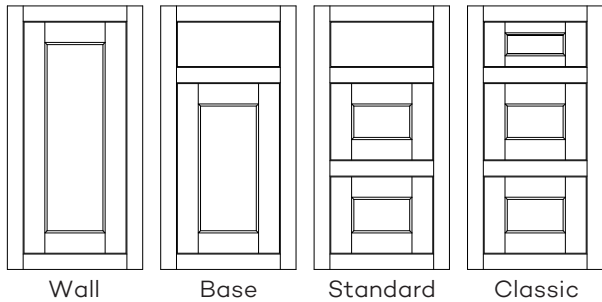

DOORS PREPPED FOR GLASS

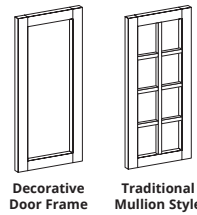

PRAIRIE INSET AVAILABLE IN PREMIER

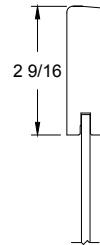

WOOD SPECIES:
Cherry, Maple, Oak, Hickory

PRICING: +15% to overlay door style

ORDERING CODE: PRA

NOTES:

- 1/16" Eased Edge Door and Drawer Front Edges with Slight Back Bevel
- Recessed Veneer Center Panel
- When painted maple is ordered the center panel will change to MDF
- Classic Drawer Front Option Available for Top Drawer

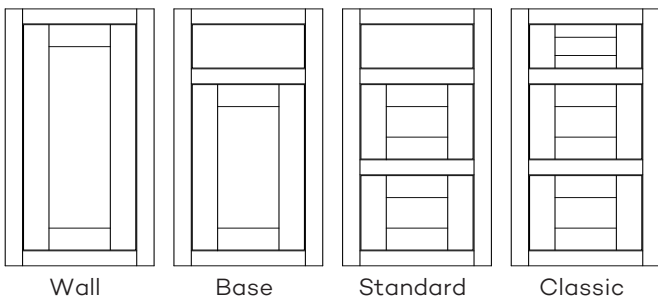

DOORS PREPPED FOR GLASS

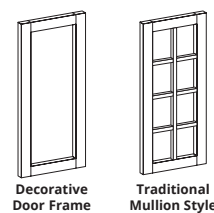

SEVILLE SQUARE INSET AVAILABLE IN PREMIER

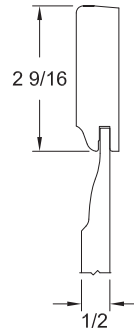

Detail

WOOD SPECIES:
Cherry, Maple, Oak,
Character Cherry, Character Maple

PRICING: +15% to overlay door style

ORDERING CODE: SVS

NOTES:

- 1/16" Eased Door and Drawer Front Edges with a Slight Back Bevel
- Solid Wood Raised Center Panel
- When painted maple is ordered the center panel will change to MDF
- Classic Drawer Front Option Available for Top Drawer
- Tolerance Around Doors and Drawers will Vary

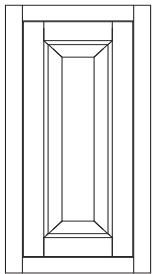

Wall

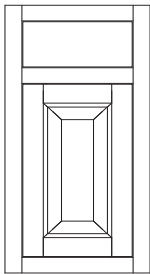

Base

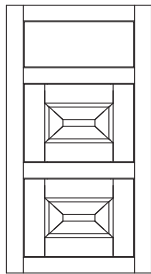

Standard

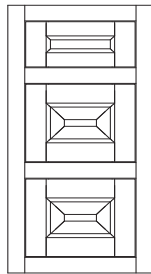

Classic

DOORS PREPPED FOR GLASS

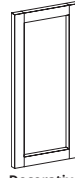

Decorative Door Frame

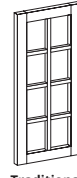

Traditional Mullion Style

EXPANDED HICKORY OFFERING

TO INCLUDE 3 SOLID CENTER PANEL DOOR STYLES

LAUNCHED 3/11/24



BEDFORD SQUARE

SELECT SERIES & ASPIRE
LUXE SERIES



HENLOW SQUARE

(OVERLAY AND INSET)
PREMIER SERIES & ASPIRE
LUXE SERIES



HANOVER

(OVERLAY AND INSET)
PREMIER SERIES & ASPIRE
LUXE SERIES

NEW FINISHES

LAUNCHED 3/11/24

ALABASTER

A neutral, warm white painted finish.

Availability: Maple, MDF, Oak

Price: Standard Paint

Ordering Code: ABT



MAPLE/MDF



OAK

BOARDWALK

A translucent stained finish that creates a weathered, bleached wood look.

Availability: Maple, Character Maple, Oak, Hickory

Price: Standard Stain

Ordering Code: BDW



MAPLE



HICKORY



OAK

PEPPERMILL

A warm, dark brown stained finish.

Availability: Cherry, Character Cherry, Maple, Character Maple, Oak, Hickory

Price: Standard Stain

Ordering Code: PRM



MAPLE



CHERRY



HICKORY



OAK

MODIFICATIONS

AVAILABLE IN PREMIER SERIES

LAUNCHED 3/11/24

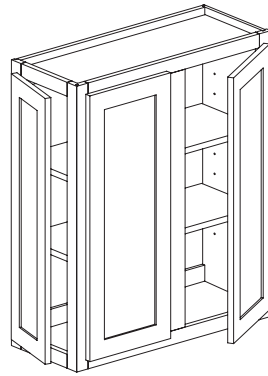

FE - FUNCTIONAL END OPTION

Functional End option will be available for Premier Inset

- Option information can be found within the current catalog
- Option pricing remains the same

Premier p. 1-121

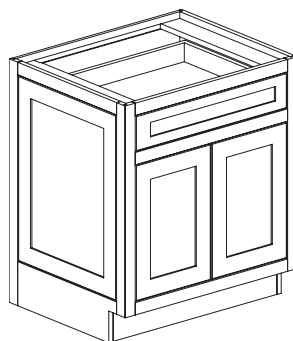

IME - INTEGRATED MATCHING END

Integrated Matching End option will be available for Premier Inset

- Option information can be found within the current catalog
- Option pricing remains the same

Premier p. 1-101

EXPANSION OF THE PDIN OPTION

NOW AVAILABLE WITH STANDARD MAPLE CABINET
 INTERIOR AND IN MORE SIZES
 LAUNCHED 9/16/24

PDIN - Pocket Doors Installed

This option changes the standard doors of the cabinet into pocket doors that slide into the cabinet out of the way. Cabinet will have an inset appearance with a shelf insert that provides the necessary room for the doors to slide into the cabinet. The shelf insert is set back 3" to allow for hinge adjustments. Interior width is 10" less than the cabinet width. **Finished Interior Finished Door (FIFD) option is available.** Available on 24" up to 36" wide, 15" to 24" deep and 18" to 54" high cabinets. This option is not available in Florence or Muriel door styles, with Modify Depth less than 15", with any kits that attach to the doors, Void Door or Box Only options.

Cabinet Width	Door Width	Cabinet Depth	PD Guide Travel	Approximate Door Protrusion
24	10 3/32	15" to 17 1/4"	7 3/8	2
27	11 19/32	15" to 17 1/4"	7 3/8	3 1/2
30	13 3/32	15" to 17 1/4"	7 3/8	5
33	14 19/32	15" to 17 1/4"	7 3/8	6 1/2
36	16 3/32	15" to 17 1/4"	7 3/8	8
24	10 3/32	17 1/2" to 18 1/2"	11 1/2	*0
27	11 19/32	17 1/2" to 18 1/2"	11 1/2	*0
30	13 3/32	17 1/2" to 18 1/2"	11 1/2	5/6
33	14 19/32	17 1/2" to 18 1/2"	11 1/2	2 1/3
36	16 3/32	17 1/2" to 18 1/2"	11 1/2	3 5/6
24	10 3/32	18 3/4" to 22 1/4"	12 7/8	*0
27	11 19/32	18 3/4" to 22 1/4"	12 7/8	*0
30	13 3/32	18 3/4" to 22 1/4"	12 7/8	*0
33	14 19/32	18 3/4" to 22 1/4"	12 7/8	1
36	16 3/32	18 3/4" to 22 1/4"	12 7/8	2 1/2
24	10 3/32	>/= 22 1/2"	16 5/8	*0
27	11 19/32	>/= 22 1/2"	16 5/8	*0
30	13 3/32	>/= 22 1/2"	16 5/8	*0
33	14 19/32	>/= 22 1/2"	16 5/8	*0
36	16 3/32	>/= 22 1/2"	16 5/8	*0

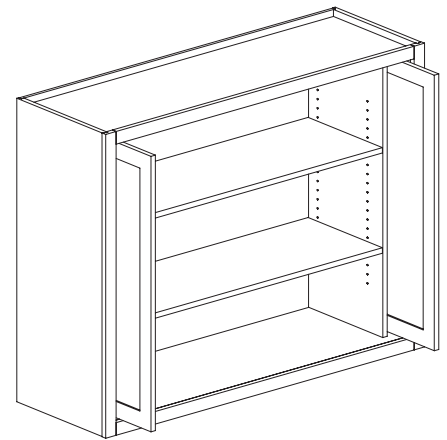

W3030 MD15 FIFD PDIN

*The addition of cabinet hardware may prevent zero protrusion.

DRAWER INSTALLED OPTION EXPANDED CABINET AVAILABILITY

LAUNCHED 9/16/24

DWRIN - Drawer Installed

This option is only available for the Double Oven Warming Drawer (DOWD) and the Triple Oven (TO) Cabinets. It adds a wood dovetail drawer with full extension soft close drawer slides where the warming drawer would be placed creating a Double Oven (DO) Cabinet with a larger drawer at the bottom. The purpose of this option is to allow the use of DOWD cabinets for large double ovens that require a cutout larger than the 52 1/4" high max cutout available in DO cabinets. The max cutout for the DOWD is 54 13/16" high and will accommodate most of the larger double ovens. This option is not available for Inset.

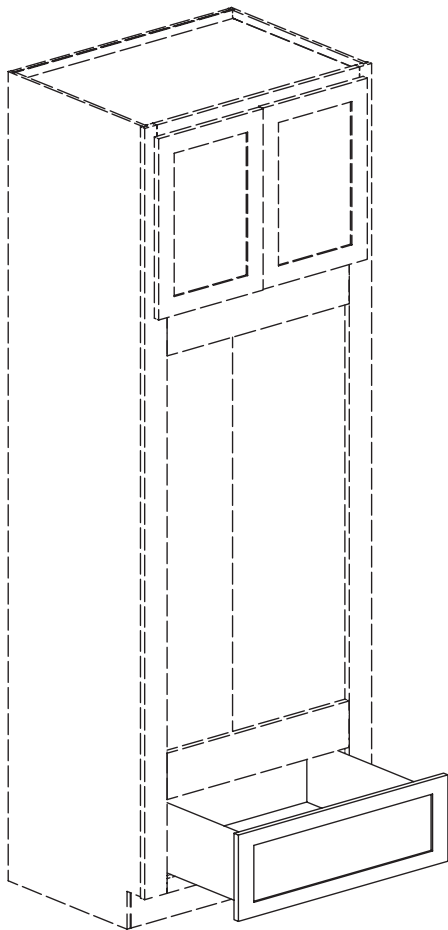

DOWD338424 DWRIN

Premier p. 1-120
Select p. 1-69

OVEN TRAY DIVIDERS AND SHELF COMBO INSTALLED

AVAILABLE IN PREMIER AND SELECT SERIES

AVAILABLE IN INSET • LAUNCHED 9/16/24

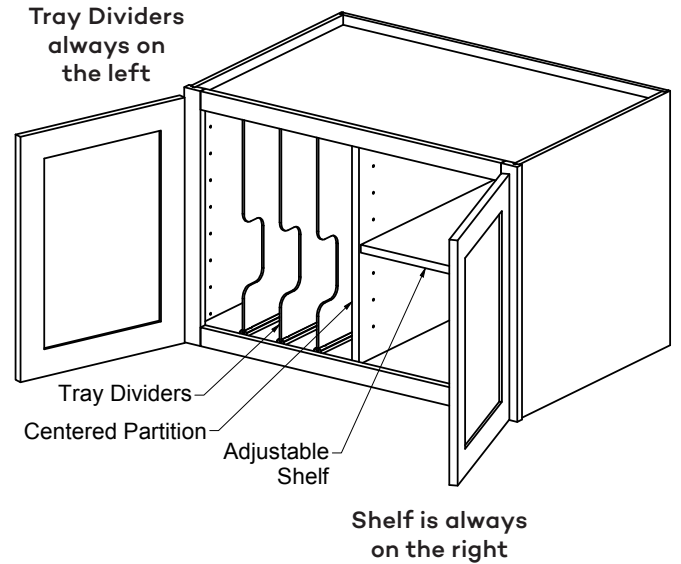

Modification that installs a partition into RW and the upper section of Tall Appliance Cabinets that divides the interior into an oven tray section containing 3 dividers on the left and a full depth adjustable shelf section on the right.

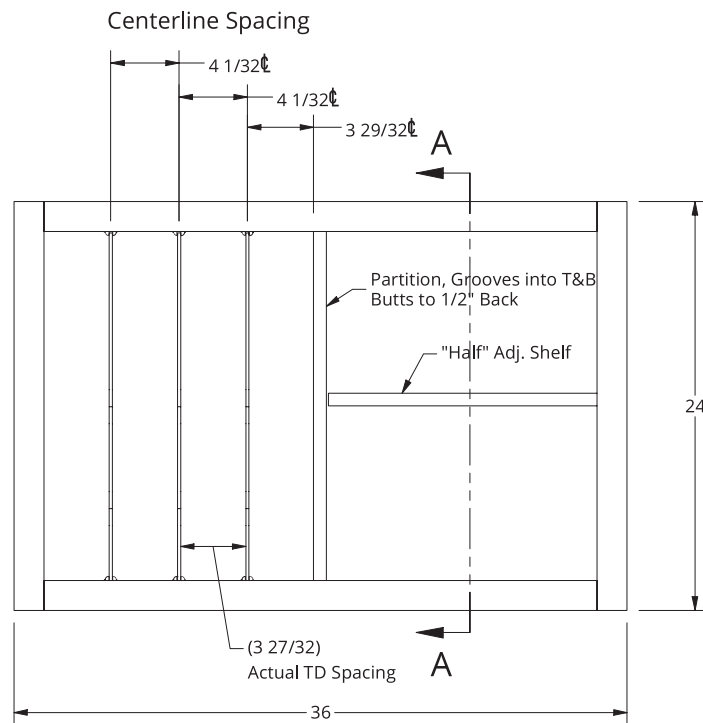

Doors Removed
 Typical TDHSIN Option in an RW362424
 Option is available in multiple cabinets -
 Option changes Wall cabinet to APC with a $\frac{1}{2}$ " back.

Select p. 1-79
 Premier p. 1-141

OTDSIN PREMIER SERIES CABINET AVAILABILITY

Available Cabinets										
Refrigerator Walls	Single Ovens	Single Oven w/Doors	Double Ovens	Microwave/ Oven Combinations	Microwave/ Single Ovens	Tall Microwaves	Tall Microwaves w/Table	Tall Microwaves w/Doors	Tall Microwaves w/Doors & Table	Microwave/ Warming Drawers
RW302724	SO278424	SOD278424	DO279024	MOC278724	MO279324	TMC278724	TMCT278724	TMCD278724	TMCDT278724	MW308724
RW303024	SO278724	SOD278724	DO279324	MOC279024	MO279624	TMC279024	TMCT279024	TMCD279024	TMCDT279024	MW309024
RW332424	SO279024	SOD279024	DO279624	MOC279324	MO309324	TMC279324	TMCT279324	TMCD279324	TMCDT279324	MW309324
RW332724	SO279324	SOD279324	DO2710224	MOC279624	MO309624	TMC279624	TMCT279624	TMCD279624	TMCDT279624	MW309624
RW333024	SO279624	SOD279624	DO309024	MOC308724	MO339324	TMC308724	TMCT308724	TMCD308724	TMCDT308724	MW338724
RW362424	SO308424	SOD308424	DO309324	MOC309024	MO339624	TMC309024	TMCT309024	TMCD309024	TMCDT309024	MW339024
RW362724	SO308724	SOD308724	DO309624	MOC309324	MO399324	TMC309324	TMCT309324	TMCD309324	TMCDT309324	MW339324
RW363024	SO309024	SOD309024	DO3010224	MOC309624	MO399624	TMC309624	TMCT309624	TMCD309624	TMCDT309624	MW339624
RW372424	SO309324	SOD309324	DO339024	MOC338724		TMC338724	TMCT338724	TMCD338724	TMCDT338724	MW398724
RW372724	SO309624	SOD309624	DO339324	MOC339024		TMC339024	TMCT339024	TMCD339024	TMCDT339024	MW399024
RW373024	SO338424	SOD338424	DO339624	MOC339324		TMC339324	TMCT339324	TMCD339324	TMCDT339324	MW399324
RW392424	SO338724	SOD338724	DO3310224	MOC339624		TMC339624	TMCT339624	TMCD339624	TMCDT339624	MW399624
RW392724	SO339024	SOD339024	DO399024							
RW393024	SO339324	SOD339324	DO399324							
RW422424	SO339624	SOD339624	DO399624							
RW452424	SO398424	SOD398424	DO3910224							
RW482424	SO398724	SOD398724								
	SO399024	SOD399024								
	SO399324	SOD399324								
	SO399624	SOD399624								

OTDSIN SELECT SERIES CABINET AVAILABILITY

Available Cabinets					
Refrigerator Walls	Single Ovens	Single Oven w/Doors	Double Ovens	Microwave Oven Combinations	Microwave/Single Ovens
RW302724	SO278424	SOD278424	DO279024	MOC308724	MO279324
RW332424	SO278724	SOD278724	DO279324	MOC309024	MO279624
RW332724	SO279024	SOD279024	DO279624	MOC309324	MO309324
RW362424	SO279324	SOD279324	DO309024	MOC309624	MO309624
RW362724	SO279624	SOD279624	DO309324	MOC338724	MO339324
RW372424	SO308424	SOD308424	DO309624	MOC339024	MO339624
RW372724	SO308724	SOD308724	DO339024	MOC339324	MO399324
RW392424	SO309024	SOD309024	DO339324	MOC339624	MO399624
RW392724	SO309324	SOD309324	DO339624		
	SO309624	SOD309624	DO399024		
	SO338424	SOD338424	DO399324		
	SO338724	SOD338724	DO399624		
	SO339024	SOD339024			
	SO339324	SOD339324			
	SO339624	SOD339624			
	SO398424	SOD398424			
	SO398724	SOD398724			
	SO399024	SOD399024			
	SO399324	SOD399324			
	SO399624	SOD399624			

FRANKLIN CDF

AVAILABLE IN SELECT SERIES
EXPANDED CLASSIC DRAWER FRONT OPTION
LAUNCHED 3/11/24



WOOD SPECIES:
Maple, Oak

SELECT PRICE COLUMN: 2
ORDERING CODE: FKN

- NOTES:
- Traditional Overlay
 - Cope & Tenon Door Construction
 - Square Door and Drawer Front Edges
 - Veneer Recessed Center Panel
 - Standard One Piece Drawer Front
 - Classic Drawer Front Option Available
NEW!

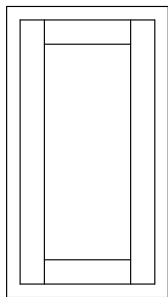

Wall

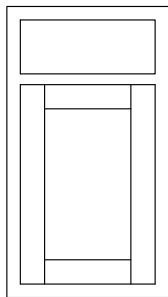

Base

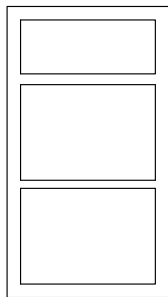

Standard

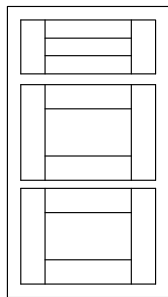

Classic

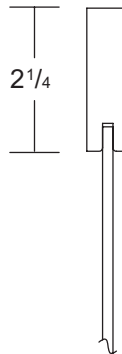

Detail

DOORS PREPPED FOR GLASS

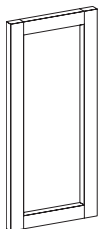

Decorative
Door Frame

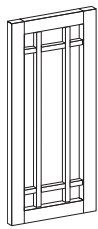

Shaker
Mullion Style

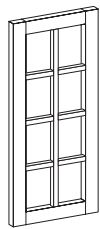

Traditional
Mullion Style

WIDE BOTTOM RAIL

NEW IN SELECT SERIES

LAUNCHED 9/16/24

WBR - Wide Bottom Rail

The Cleaning Utility and Spice Utility cabinets are available with the Wide Bottom Rail option. The cabinet interior does not change with this option. Not available with the Inverted Frame Option. This option eliminates the toe kick.

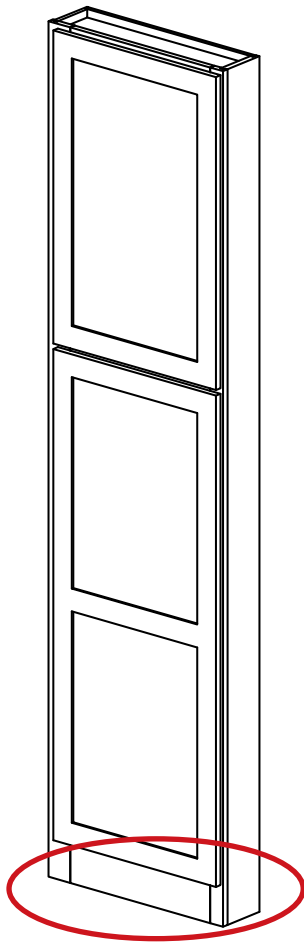

SUC249606L WBR

Select p. 1-89

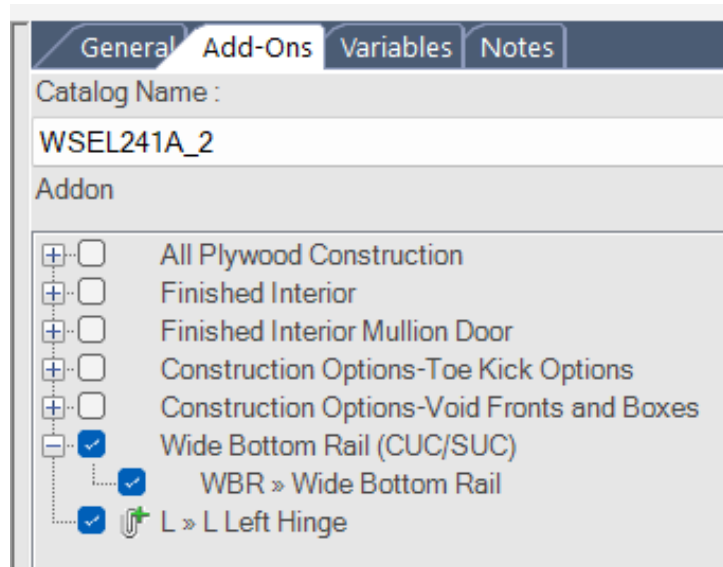

BOX HOOD EXPANSION

AVAILABLE IN ASPIRE, PREMIER AND SELECT SERIES

NOW INCLUDES 18" HEIGHT
X-PATTERN HOOD NOT INCLUDED DUE TO HEIGHT
LAUNCHED 9/16/24

SLAB FRONT BOX HOOD

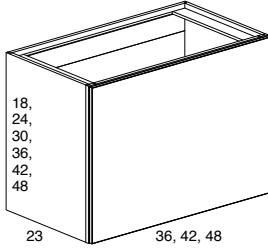

NEW BH3618SF	NEW BH4218SF	NEW BH4818SF
BH3624SF	BH4224SF	BH4824SF
BH3630SF	BH4230SF	BH4830SF
BH3636SF	BH4236SF	BH4836SF
BH3642SF	BH4242SF	BH4842SF
BH3648SF	BH4248SF	BH4848SF

SHAKER BOX HOOD

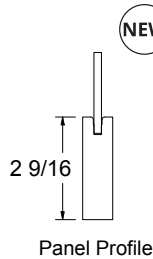
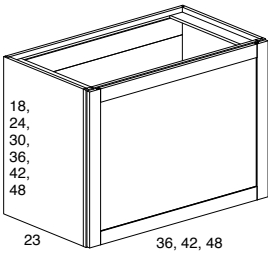

NEW BH3618SKR	NEW BH4218SKR	NEW BH4818SKR
BH3624SKR	BH4224SKR	BH4824SKR
BH3630SKR	BH4230SKR	BH4830SKR
BH3636SKR	BH4236SKR	BH4836SKR
BH3642SKR	BH4242SKR	BH4842SKR
BH3648SKR	BH4248SKR	BH4848SKR

TRANSITIONAL BOX HOOD

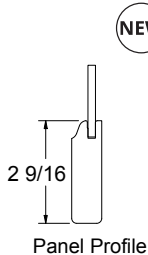
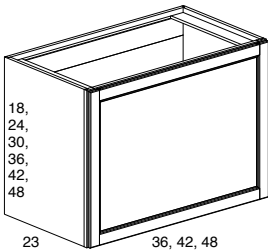

NEW BH3618TR	NEW BH4218TR	NEW BH4818TR
BH3624TR	BH4224TR	BH4824TR
BH3630TR	BH4230TR	BH4830TR
BH3636TR	BH4236TR	BH4836TR
BH3642TR	BH4242TR	BH4842TR
BH3648TR	BH4248TR	BH4848TR

MATCHING DOORS BOX HOOD

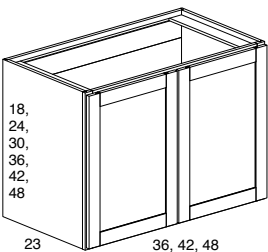

NEW BH3618D	NEW BH4218D	NEW BH4818D
BH3624D	BH4224D	BH4824D
BH3630D	BH4230D	BH4830D
BH3636D	BH4236D	BH4836D
BH3642D	BH4242D	BH4842D
BH3648D	BH4248D	BH4848D

2 Doors with center mullion

Select p. 2-20
Premier p. 2-42
Aspire p. 2-30

6" BASE TRAY CABINET

AVAILABLE IN ASPIRE, PREMIER AND SELECT SERIES

NOT AVAILABLE IN INSET FOR PREMIER SERIES
LAUNCHED 9/16/24

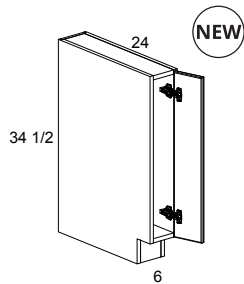

NEW

BT6 L/R

**1 Door,
No shelf**

- Finished interior and exterior standard
- Not available in TOL door styles
- One piece full overlay filler trim with complementary edge profile
- Sides, top and bottom have 3/4" plywood frameless construction
- **Finish techniques are not included**
- **For MDF door styles, cabinet is painted hardwood**
- **INSET:** Not available

WIDTH		HEIGHT		DEPTH	
Min.	Max.	Min.	Max.	Min.	Max.
				6"	30"

Modification	APC	BO	CC	ES	FCE	FDBS	FH	FI	FIMD	FO	ID	IF	IME	MFE	MD	MH	MW	P	PCE	RD	RTK	TKA	VTK	WBR	WCM	WS	WTR
FOL/TOL	▲				▲			▲						▲	•					•		▲	•				

Select and Premier Specs

Select p. 3-1
Premier p. 3-2

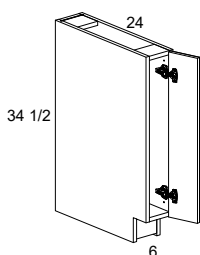

NEW

BT6 L/R

**1 Full height door,
No Shelf**

- **Must specify L or R hinge**

Modification	APC	BO	FH	FI	FIMD	FME	IC	ID	MD	MH	MW	P	RD	RTK	TKA	VTK
LUX	•	•	▲	•		•			•	•	•		•		▲	•

Aspire Specs

Aspire p. 3-1

6" BASE TRAY CABINET

BT6 DOOR IS A 6" FILLER TRIM

SEE CHART BELOW FOR COMPLIMENTING FILLER TRIM
BASED ON SELECTED DOOR

Square



Florence, Hanover,
Muriel,
Prairie, Urban, York

Eased



Amelia, Antigua, Alto,
Bishop, Chelsea II, Collins,
Galena, Harbour, Lexington,
Melrose, Milan, Monterey,
Marlow, Napa, New Haven,
Ridgebrook, Savannah,
Sandia, Sonoma, Saybrook,
Trestle, Wyatt, Hancock

Step Edge



Davenport Square,
Harmony, Henlow, Bedford,
Concord, Millbrook Square,
Preston

Classic



Belmont, Hartford,
Camden Square

Decorative



Beaumont, Seville Square

Breckenridge



Breckenridge

TWO DRAWER BASE CABINET WITH HIDDEN DRAWER

AVAILABLE IN PREMIER SERIES AND ASPIRE
LAUNCHED 9/16/24

NEW 33" ADDITION

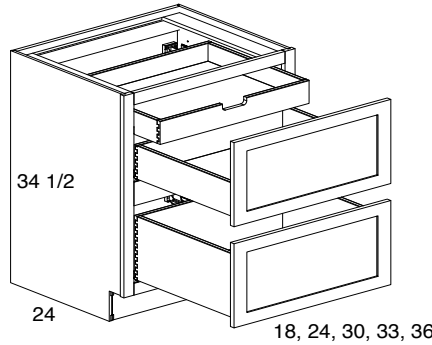

- 2DB18HD
- 2DB24HD
- 2DB30HD
- 2DB33HD **(NEW)**
- 2DB36HD

**2 Drawers,
1 Hidden drawer inside
top drawer**

Premier p. 3-6
Aspire p. 3-3

DRAWER BASE CABINET SIZE ADDITIONS

AVAILABLE IN PREMIER SERIES
LAUNCHED 9/16/24

THREE DRAWER BASE CABINETS

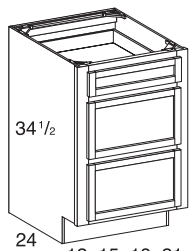

12, 15, 18, 21, 24,
27, 30, 33, 36, 39, 42

- 3DB12
- 3DB15
- 3DB18
- 3DB21
- 3DB24
- 3DB27
- 3DB30
- 3DB33
- 3DB36
- 3DB39

3 Drawers

3DB42 **(NEW)**

FOUR DRAWER BASE CABINETS

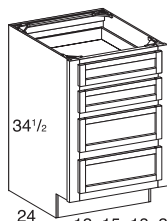

12, 15, 18, 21, 24,
27, 30, 33, 36, 39, 42

- 4DB12
- 4DB15
- 4DB18
- 4DB21
- 4DB24
- 4DB27
- 4DB30
- 4DB33
- 4DB36
- 4DB39 **(NEW)**

4 Drawers

4DB42 **(NEW)**

Premier p. 3-7

WASTEBASKET CUTTING BOARD CABINETS

AVAILABLE IN ASPIRE, PREMIER AND SELECT SERIES
LAUNCHED 9/16/24

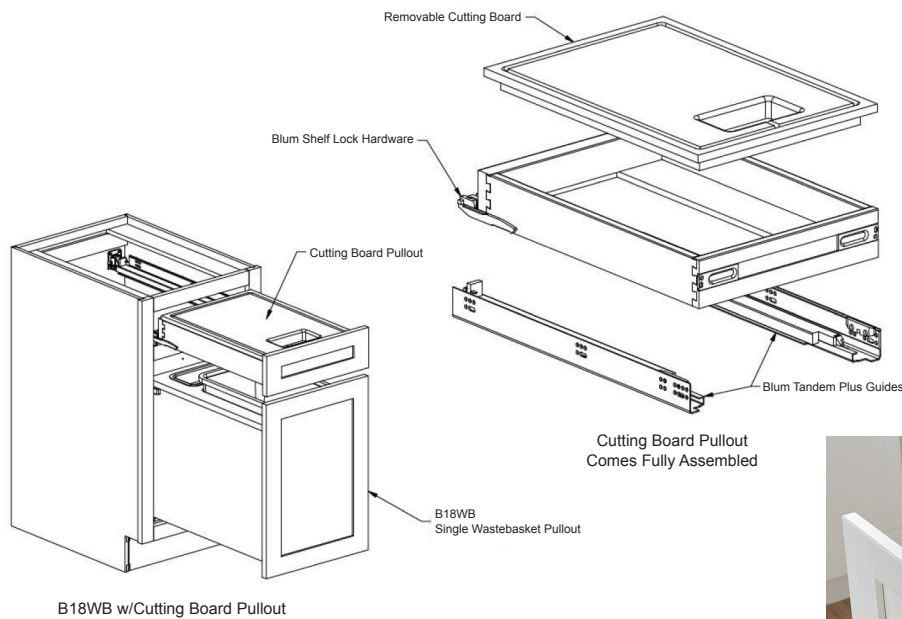
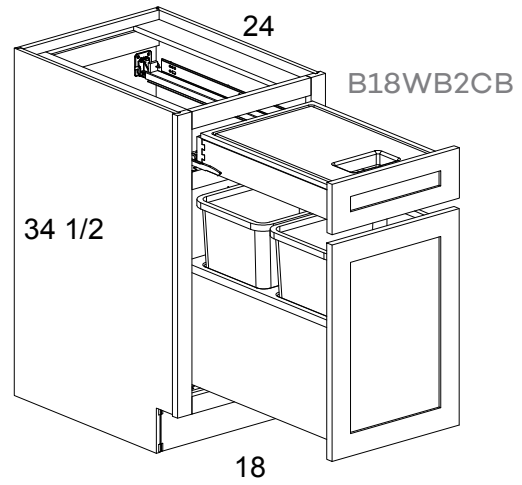
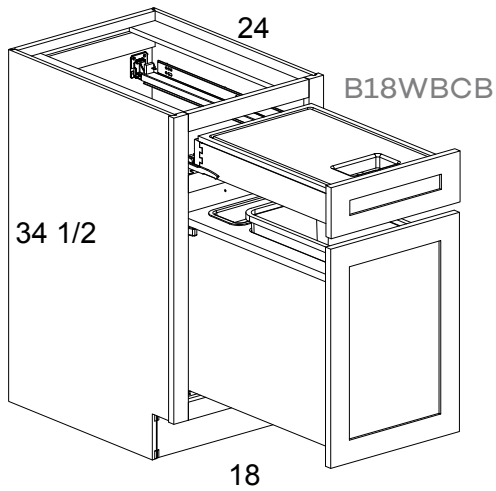

Aspire p. 3-10
Premier p. 3-13
Select p. 3-10

WASTEBASKET CUTTING BOARD CABINETS

(CONTINUED)

WASTEBASKET CUTTING BOARD CABINETS

NEW

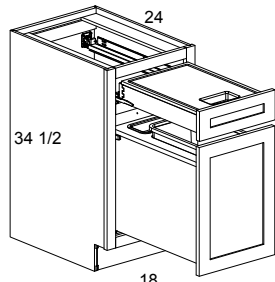

B18WBCB

**1 Drawer,
1 Door**

- Drawer contains removable cutting board containing a drip groove that runs to 3" x 5 1/2" disposal hole
- Drawer includes a locking feature providing a stable and secure work surface
- 90 lb weight capacity
- One 35 quart capacity basket
- **INSET:** Contains a different wastebasket kit

TOL & FOL

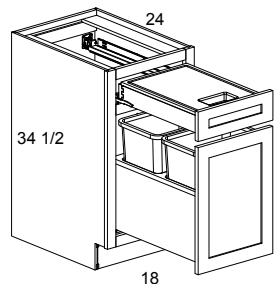

B18WB2CB

**1 Drawer,
1 Door**

- Drawer contains removable cutting board containing a drip groove that runs to 3" x 5 1/2" disposal hole
- Drawer includes a locking feature providing a stable and secure work surface
- 90 lb weight capacity
- Two 35 quart capacity baskets fitted into individual openings
- **INSET:** Contains a different wastebasket kit

TOL & FOL

WIDTH		HEIGHT		DEPTH	
Min.	Max.	Min.	Max.	Min.	Max.
				24"	30"

Modification	APC	BO	CC	ES	FCE	FDBS	FH	FI	FIMD	FO	ID	IF	IME	MFE	MD	MH	MW	P	PCE	RD	RTK	TKA	VTK	WBR	WCM	WS	WTR	
FOL/TOL	•				•									•	•	•						•	▲	•				•
INS	•				•									•	•	•						•	▲	•				•

Select p. 3-10

Premier p. 3-13 (Shown)

WASTEBASKET CUTTING BOARD CABINETS

NEW

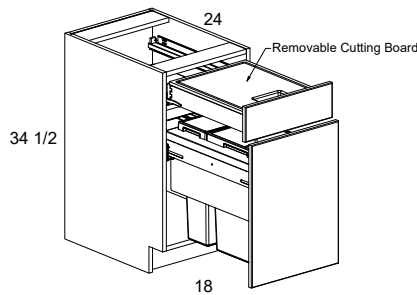

B18WBCB

**1 Drawer,
1 Door**

- Drawer contains removable cutting board containing a drip groove that runs 3" x 5 1/2" disposal hole
- Drawer includes a locking feature providing a stable and secure work surface
- 90 lb weight capacity
- BH18WB has one 44 quart and one 12 quart bins
- Kit includes a metal partition between the wastebasket and drawer
- Gray and natural interiors will get gray bins
- White interiors will get white bins

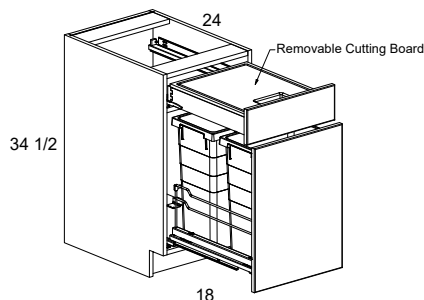

B18WB2CB

**1 Drawer,
1 Door**

- Drawer contains removable cutting board containing a drip groove that runs 3" x 5 1/2" disposal hole
- Drawer includes a locking feature providing a stable and secure work surface
- 90 lb weight capacity
- Two 36 quart capacity bins
- Includes a partition between the wastebasket and drawer
- Gray and natural interiors will get gray bins
- White interiors will get white bins

Aspire p. 3-10

CLEANING UTILITY CABINET

AVAILABLE IN PREMIER AND SELECT SERIES
LAUNCHED 9/16/24

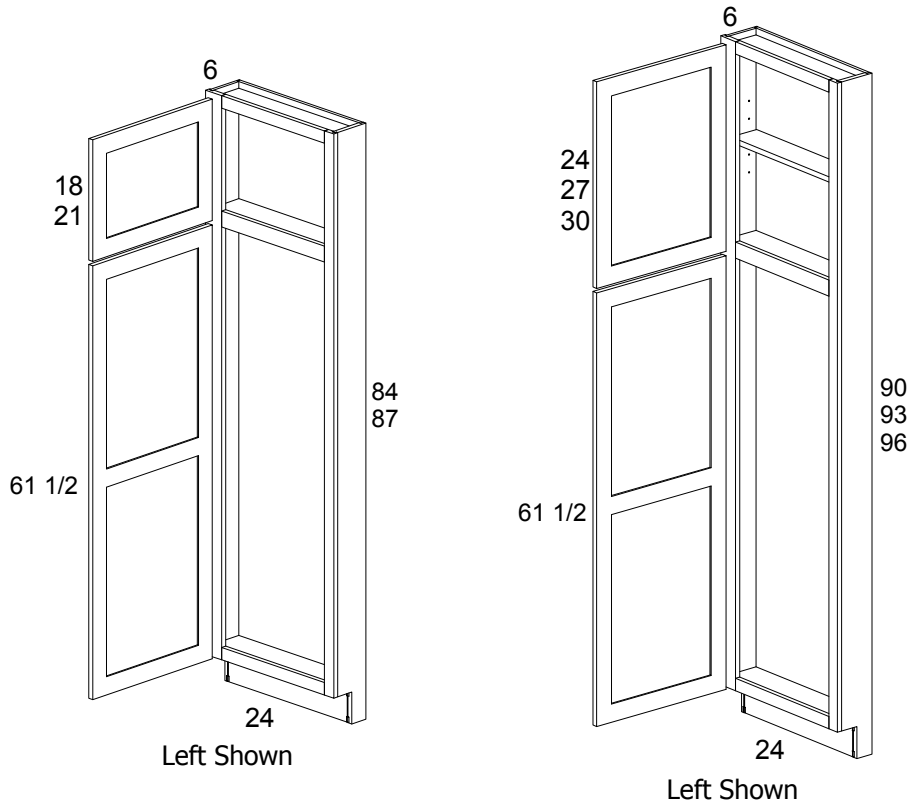

Select p. 5-5
Premier p. 5-9

CUC248406L
CUC248406R

CUC248706L
CUC248706R

2 Doors

- Codes specify Left or Right Wide Stile side
- Cabinet has 1 1/4" Wide Stile and will be hinged on the side with the Wide Stile
- Doors will not line up with adjacent cabinets
- Bottom door opening in 59 1/4" high
- Exposed side is standard FCE
- Order a Tall Filler Trim separately for a finished look

CUC249006L
CUC249006R

CUC249306L
CUC249306R

2 Doors, 1 Adj. shelf

- Codes specify Left or Right Wide Stile side
- Cabinet has 1 1/4" Wide Stile and will be hinged on the side with the Wide Stile
- Doors will not line up with adjacent cabinets
- Bottom door opening is 59 1/4" high
- Exposed side is standard FCE
- Order a Tall Filler Trim separately for a finished look



SPICE UTILITY CABINET

AVAILABLE IN PREMIER AND SELECT SERIES
LAUNCHED 9/16/24

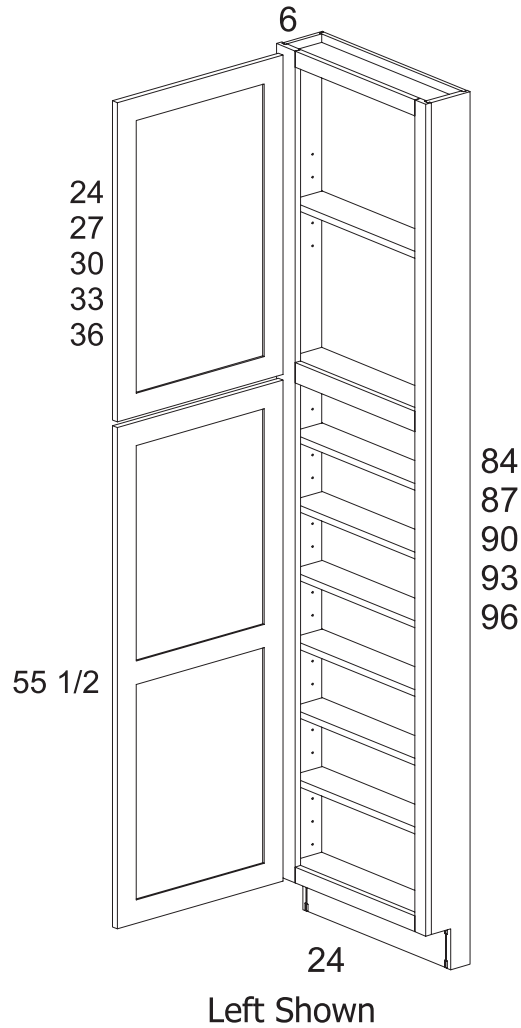

Select p. 5-5
Premier p. 5-10

Premier Specs

SUC248406L	SUC248706L	SUC249006L
SUC248406R	SUC248706R	SUC249006R
SUC249306L	SUC249606L	
SUC249306R	SUC249606R	

2 Doors, 7 Adj. shelves

- Codes specify Left or Right Wide Stile side
- Cabinet has 1 1/4" Wide Stile and will be hinged on the side with the Wide Stile
- Exposed side is standard FCE
- Order a Tall Filler Trim separately for a finished look

Select Specs

SUC248406L	SUC248706L	SUC249006L
SUC248406R	SUC248706R	SUC249006R
SUC249306L	SUC249606L	
SUC249306R	SUC249606R	

2 Doors, 7 Adj. shelves

- Codes specify Left or Right Wide Stile side
- Cabinet has 1 1/4" Wide Stile and will be hinged on the side with the Wide Stile
- Exposed side is standard FCE
- Order a Tall Filler Trim separately for a finished look
- Wide Bottom Rail (WBR) option available

VANITY POWER PULLOUT CABINET

AVAILABLE IN PREMIER SERIES

LAUNCHED 9/16/24

NOT AVAILABLE IN INSET

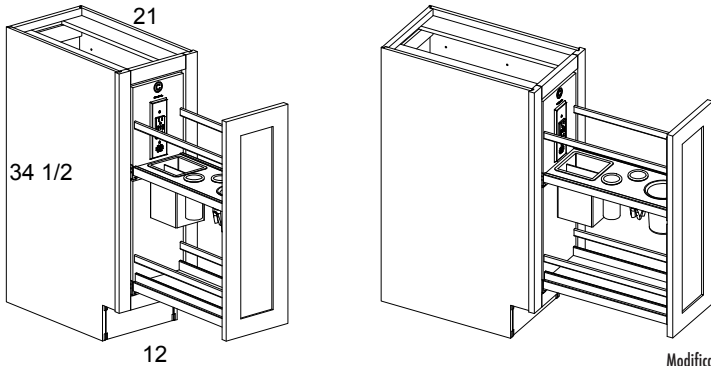

VPPO12BH

- Pullout is wood
- Contains three poly trays and a non-slip mat on fixed bottom shelf
- Built in 15 amp UL listed dual outlets in the back
- Round stainless-steel canisters for appliances and a square stainless-steel canister for cord storage in the top shelf
- **INSET:** Not available

WIDTH		HEIGHT		DEPTH	
Min.	Max.	Min.	Max.	Min.	Max.
				21"	30"

Modification	APC	BO	CC	ES	FCE	FDBS	FH	FI	FIMD	FO	ID	IF	IME	MFE	MD	MH	MW	P	PCE	RD	RTK	TKA	VTK	WBR	WCM	WS	WTR
FOL/TOL	•	•	•	•	•	•	▲				•		•	•	•							•	▲	•	•		

Premier p. 6-20

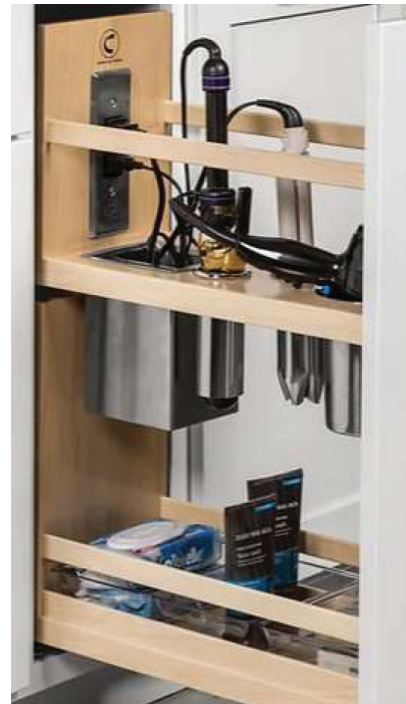

POCKET DOOR STACK CABINETS WITH VOID BOTTOM RAIL

AVAILABLE IN PREMIER SERIES
LAUNCHED 9/16/24

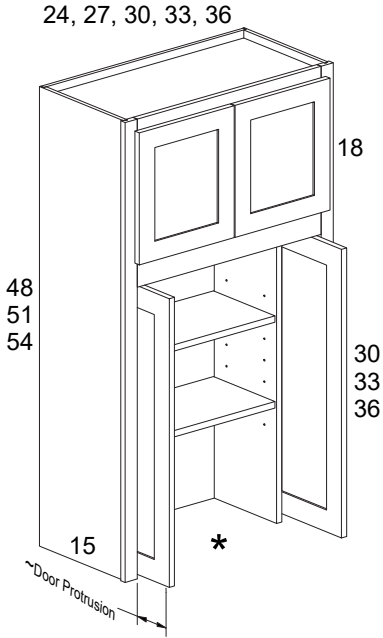

Premier p. 2-23

PDSC244815VBR	PDSC245115VBR	PDSC245415VBR
PDSC274815VBR	PDSC275115VBR	PDSC275415VBR
PDSC304815VBR	PDSC305115VBR	PDSC305415VBR
PDSC334815VBR	PDSC335115VBR	PDSC335415VBR
PDSC364815VBR	PDSC365115VBR	PDSC365415VBR

4 Doors w/o center mullion, 2 Adj. shelves

- Cabinet does not have a floor, has a back in lower area and is meant to sit on the countertop
- 18" High upper section is available with Decorative Door Frame or Mullion Door Modifications
- FOL reveal is 2 3/16" between top and bottom doors
- TOL reveal is 3" between top and bottom doors
- **INSET:** Reveal is 3 1/2" between top and bottom doors
- * Interior width between partitions = Cabinet Width - 10"

Cabinet Width	Door Width	Cabinet Depth	PD Guide Travel	Approximate Door Protrusion
24	10 3/32	15" to 17 1/4"	7 3/8	2
27	11 19/32	15" to 17 1/4"	7 3/8	3 1/2
30	13 3/32	15" to 17 1/4"	7 3/8	5
33	14 19/32	15" to 17 1/4"	7 3/8	6 1/2
36	16 3/32	15" to 17 1/4"	7 3/8	8
24	10 3/32	17 1/2" to 18 1/2"	11 1/2	*0
27	11 19/32	17 1/2" to 18 1/2"	11 1/2	*0
30	13 3/32	17 1/2" to 18 1/2"	11 1/2	7/8
33	14 19/32	17 1/2" to 18 1/2"	11 1/2	2 3/8
36	16 3/32	17 1/2" to 18 1/2"	11 1/2	3 7/8
24	10 3/32	18 3/4" to 22 1/4"	12 7/8	*0
27	11 19/32	18 3/4" to 22 1/4"	12 7/8	*0
30	13 3/32	18 3/4" to 22 1/4"	12 7/8	*0
33	14 19/32	18 3/4" to 22 1/4"	12 7/8	1
36	16 3/32	18 3/4" to 22 1/4"	12 7/8	2 1/2
24	10 3/32	>= 22 1/2"	16 5/8	*0
27	11 19/32	>= 22 1/2"	16 5/8	*0
30	13 3/32	>= 22 1/2"	16 5/8	*0
33	14 19/32	>= 22 1/2"	16 5/8	*0
36	16 3/32	>= 22 1/2"	16 5/8	*0

*The addition of cabinet hardware may prevent zero protrusion.

WIDTH		HEIGHT		DEPTH	
Min.	Max.	Min.	Max.	Min.	Max.
24"	36"	42"	54"	15"	30"

Modification	APC	BO	CC	ES	FCE	FDBS	FH	FI	FMD	FO	ID	IF	IME	MFE	MD	MH	MW	P	PCE	RD	RTK	TKA	VTK	WBR	WCM	WS	WTR
FOL/TOL	▲			•	•			•	•	•				•	•	•	•								▲		
INS	▲			•	•			•	•	•				•	•	•	•								▲		

24" DEEP SLIDING SHELF KITS

AVAILABLE IN ASPIRE, PREMIER AND SELECT SERIES
LAUNCHED 9/16/24

NOT AVAILABLE IN INSET FOR PREMIER SERIES

24" DEEP, SLIDING SHELF KITS - 2 SLIDING SHELVES NEW

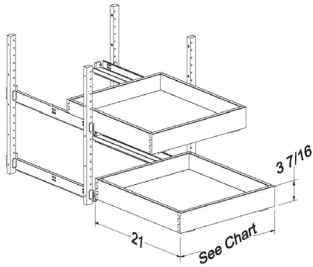

2SSSC1224
2SSSC1524
2SSSC1824
2SSSC2124
2SSSC2424
2SSSC2724
2SSSC3024
2SSSC3324
2SSSC3624

- Kit contains two (2) sliding shelves and one set of base height support sticks that are 23 3/16" high
- **INSET:** Not available

Cabinet Width	SS Nomenclature	SS Width
12	2SSSC1224	7 1/2
15	2SSSC1524	10 1/2
18	2SSSC1824	13 1/2
21	2SSSC2124	16 1/2
24	2SSSC2424	19 1/2
27	2SSSC2724	22 1/2
30	2SSSC3024	25 1/2
33	2SSSC3324	28 1/2
36	2SSSC3624	31 1/2

24" DEEP, SLIDING SHELF KITS - 4 SLIDING SHELVES NEW

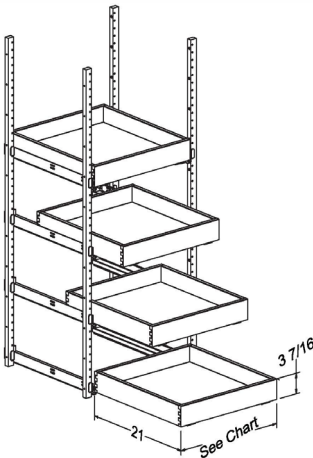

4SSSC1224
4SSSC1524
4SSSC1824
4SSSC2124
4SSSC2424
4SSSC2724
4SSSC3024
4SSSC3324
4SSSC3624

- Available in wood only
- Kits contains four (4) sliding shelves and one set of tall Utility height support sticks that are 52 1/8" high

Cabinet Width	SS Nomenclature	SS Width
12	4SSSC1224	7 1/2
15	4SSSC1524	10 1/2
18	4SSSC1824	13 1/2
21	4SSSC2124	16 1/2
24	4SSSC2424	19 1/2
27	4SSSC2724	22 1/2
30	4SSSC3024	25 1/2
33	4SSSC3324	28 1/2
36	4SSSC3624	31 1/2

Select p. 3-20, 5-7 • Premier p. 3-30, 5-12, 5-13 • Aspire p. 3-24, 5-8

SLIDING SHELF SUPPORTS

LAUNCHED 9/16/24

SLIDING SHELVES SUPPORTS NEW

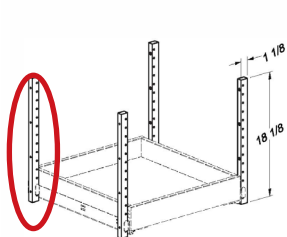

Standard Bases with Top Drawer
SSB_PK4

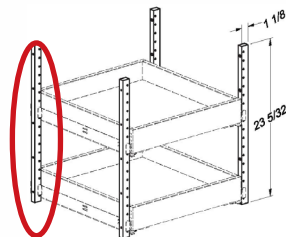

FH Bases
SSBFH_PK4

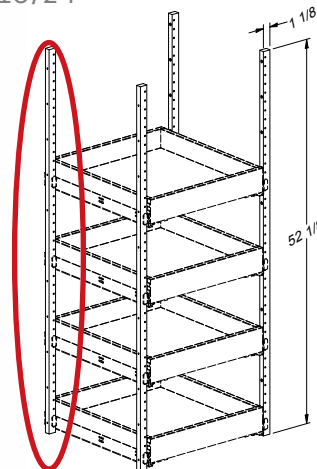

Tall Cabinets
SST_PK4

Available in wood only
Includes a pack of four (4) mounting supports

Select p. 3-21, 5-8, 11-1 • Premier p. 3-31, 5-13, 11-1 • Aspire p. 3-25, 5-8, 11-3

ASPIRE METAL DOOR STYLE AND FINISH/INSERT CHANGES

LAUNCHED 9/16/24

Door Style	Frame Finishes	Standard Glass	Back Painted Glass	Architectural Resin	Leather
Marsala (AF002)	Natural Aluminum	Satin	White Gloss	Quattro Carbon	Coal Buffalo
Sterling (AF003)	Brushed Stainless	Clear	White Matte	Wisp Silver	Antique Brown Walrus
Fresno (AF004)	Onyx	Reeded	Black Gloss	Linea Ivory	Grey Thunder Buffalo
Rivera (AF005)	Gold	Listral D	Black Matte	Swept Gold	Black Shagreen
Serenity (AF006)	Graphite	Low Iron Satin	Sand Gloss	Swept Silver	Cocoa Buffalo
Alexandria (AF007)	Modern Brass	Low Iron Clear	Sand Matte	Fossil Leaf	Gold Gray Mettalic
Aurora (AF009)	Copper	Grey Clear	Cream Gloss	Thatch	Grey Stone Shagreen
Vista (AF010)	Luxe Bronze	Grey Satin	Cream Matte	Struck Pure	Pebble Shagreen
Lynton (AF011)	Arctic Silver	Bronze Clear	Navy Gloss	Starcrossed Shadow	Umber Gray Buffalo
Carlisle (AF013)	Chalk	Bronze Satin	Navy Matte	Strand Iron	
Naples (AF014)	Bronze Matte	Mirror	Slate Gloss	Ensign	
			Slate Matte	Mari Seamless	
			Mist Gloss	Weld Silver	
			Mist Matte	Kathali Greys	
			Bronze Gloss	Glint Gold	
			Bronze Matte	Gold Weave Metallic	
			Blush Gloss	Tribe Pure	
			Blush Matte	Vera Pure	
			Aqua Gloss	Villa Pure	
			Aqua Matte	Woven Lotka Pure	
			Oasis Gloss		
			Oasis Matte		
			Amarillo Gloss		
			Amarillo Matte		
			Sienna Gloss		
			Sienna Matte		

Green = Additions

Red = Deletions

PRICE CHANGES

EFFECTIVE IN SELECT SERIES

SIMPLIFYING AND DECREASING THE NUMBER OF PRICE COLUMNS
EFFECTIVE 3/11/24

PREVIOUS PRICE COLUMN STRUCTURE

1	2	3	4	5	6
Arlington Square MPL	Alto MDF	Bishop MDF	Trestle MDF	Belmont MDF	Bedford Square MPL
Hancock MDF	Franklin MPL	Camden Square MDF		Hartford MDF	Concord MPL
	Preston MDF	Harmony MPL		Harvest Square MPL	
		Millbrook Square MPL		Prarie MPL	
		Preston MPL			
		Urban MPL			

CURRENT PRICE COLUMN STRUCTURE

1	2	3	4	5
Arlington Square MPL	Alto MDF	Bishop MDF	Harvest Square MPL	Bedford Square MPL/HKY
Hancock MDF	Franklin MPL	Camden Square MDF	Prarie MPL/HKY	Concord MPL
	Preston MDF	Harmony MPL		
		Millbrook Square MPL		
		Preston MPL		
		Urban MPL		

Select Series price column changes do not result in any list price changes.

IMPORTANT: Harmony become a Select Series only door style while Belmont, Hartford and Trestle become Premier Series only styles.

PRICE CHANGES

EFFECTIVE IN PREMIER SERIES

SIMPLIFYING AND DECREASING THE NUMBER OF PRICE COLUMNS

PREVIOUS PRICE COLUMN STRUCTURE

7	8	9	10	11	12	13	14	15	16
Essex MPL	Bishop MDF	Alto MDF	Amelia MDF	Lexington MPL	Davenport Square MPL	Hanover CMP	Madison Square CMP	Antigua MPL	Savannah MPL
	Harmony MPL	Florence MPL	Amelia MPL	Milan MPL	Harbour MPL	Hanover MPL	Madison Square MPL	Brisb I CMP	
		Muriel MDF	Belmont MDF	Rose Hall Arch CMP	Henlow Square MPL			Brisb I MPL	
		Saybrook MDF	Galena Square MDF	Rose Hall Arch MPL	Napa MPL			Chelsea II MDF	
		Trestle MDF	Galena Square MPL	Rose Hall Square CMP	New Haven MPL			Chelsea II MPL	
			Hartford MDF	Rose Hall Square MPL	Seville Arch CMP			Cortland CMP	
			Prairie MPL	Sandia MPL	Seville Arch MPL			Cortland MPL	
					Seville Square CMP			Melrose MPL	
					Seville Square MPL			Messina MPL	
					Sonoma MPL			Monterey MPL	
								Richmond MPL	
								Vienna MPL	
								Winslow MPL	

CURRENT PRICE COLUMN STRUCTURE

6	7	8	9	10	11
Essex MPL	Alto MDF	Amelia MPL/MDF	Breckenridge MPL/MDF	Beaumont MPL/CMP	Antigua MPL
Everett MPL/MDF	Bishop MDF	Belmont MDF	Lexington MPL	Collins MPL/CMP	Chelsea II MPL/MDF
Langley MPL/MDF	Florence MPL	Galena Square HKY	Milan MPL	Davenport Square MPL	Melrose MPL
	Muriel MPL	Galena Square MPL/MDF	Ridgebrook MPL/MDF	Hanover MPL/CMP	Monterey MPL
	Saybrook MDF	Hartford MDF	Rose Hall Square MPL/CMP	Hanover HKY	Savannah MPL
	Trestle MDF	Prairie MPL	Sandia MPL	Harbour MPL	
		Prairie HKY		Henlow Square HKY	
				Henlow Square MPL	
				Marlow MPL/CMP	
				Napa MPL	
				New Haven MPL	
				Seville Square MPL/CMP	
				Sonoma MPL	
				Wyatt MPL/MDF	

Premier Series price column changes do result in some list price changes. Essex moves into the price column with Bishop and becomes the same list price. Bishop moves into the Alto price column and becomes the same list price. Hanover moves into the Davenport price column and becomes the same list price. Savannah moves down a column and becomes the same list price as Antigua. Hanover and Savannah both see a price decrease.

PRICE CHANGES

EFFECTIVE IN ASPIRE LUXE SERIES

SIMPLIFYING AND DECREASING THE NUMBER OF PRICE COLUMNS
COLUMN CHANGES DO NOT RESULT IN LIST PRICE CHANGES

PREVIOUS PRICE COLUMN STRUCTURE

1	2	3	4	5	6	7	8	9	10
Arcadia EBM Bel-Air EBM	Alto MDF Hancock MDF	Preston MDF Urban MPL	Amelia MPL/MDF Bedford Square MPL Belmont MDF Bishop MDF Camden Square MDF Florence MPL Galena Square MPL/MDF Hartford MDF Millbrook Square MPL Muriel MPL Prairie MPL Preston MPL Saybrook MDF Trestle MDF	Davenport Square MPL Harbour MPL Henlow Square MPL Lexington MPL Milan MPL New Haven MPL Sandia MPL Seville Arch Square MPL/CMP	Hanover MPL/CMP Napa MPL Sonoma MPL	Morristown EBM	Madison Square MPL/CMP	Antigua MPL Bristol MPL/CMP Chelsea II MPL/MDF Cortland MPL/CMP Melrose MPL Messina MPL Midtown DLM Monterey MPL Richmond MPL Soho DLM Vienna MPL Winslow MPL	Savannah MPL

CURRENT PRICE COLUMN STRUCTURE

1	2	3	4	5	6	7	8	9
Arcadia EBM Bel-Air EBM	Alto MDF Hancock MDF	Preston MDF Urban MPL	Amelia MPL/MDF Bedford Square MPL/HKY Belmont MDF Bishop MDF Camden Square MDF Florence MPL Galena Square MPL/MDF/HKY Hartford MDF Millbrook Square MPL Muriel MPL Prairie MPL/HKY Preston MPL Saybrook MDF Trestle MDF	Davenport Square MPL Harbour MPL Henlow Square MPL/HKY Lexington MPL Milan MPL New Haven MPL Sandia MPL Seville Square MPL/CMP	Hanover MPL/CMP/HKY Napa MPL Sonoma MPL	Morristown EBM	Antigua MPL Beaumont MPL/CMP Breckenridge MPL/MDF Chelsea II MPL/MDF Collins MPL/CMP Marlow MPL/CMP Melrose MPL Midtown DLM Monterey MPL Ridgebrook MPL/MDF Soho DLM Wyatt MPL/MDF	Savannah MPL

Aspire Luxe Series price column changes do not result in any list price changes.

FINISH TECHNIQUE DELETIONS

PREMIER SERIES AND ASPIRE
EFFECTIVE 9/16/24



Heirloom

Family Heritage

- Burnishing
- Small Dents
- Worm Holes
- Glaze Required for Maple, Character Maple, Oak and Hickory
- Available on Stains and Stains with Glazes on Cherry and Character Cherry



Antique

Aged With Care

- Burnishing
- Rub Through
- Small Dents
- Worm Holes
- Glaze Required for Maple, Character Maple, Oak and Hickory
- Glaze Optional for Cherry and Character Cherry



Olde World

Artisan Finish

- Burnishing
- Rub Through
- Worm Holes
- Dry Brush Glazing
- Carved Edges
- Small to Medium Dents
- Rasping
- Glaze Required for Maple, Character Maple, Oak and Hickory
- Glaze Optional for Cherry and Character Cherry

WELLBORN CABINET®

38669 Highway 77 | Ashland, AL 36251
(256) 354-7151 | Fax (256) 354-7022
wellborn.com



Due to the limitations of photography and the lithographic printing process the door materials shown in this brochure may not accurately depict those offered by Wellborn Cabinet, Inc. See your local Wellborn Dealer for actual sample color selections. Decorative hardware shown is optional. Doors made with solid wood stiles and rails with plywood veneer center panels will vary in finish from the stiles and rails to the center panel due to the difference in materials. This is not considered a defect and is not covered under warranty.



Digital Brochure



B8728
Copyright © May 2018
Print Date: January 2024
Effective Date: September 16, 2024